



KFLDHS50Q465

Rhine, LED Flood Light, 50W



Product Overview

The Kosnic Rhine LED Floodlights make ideal replacements for energy-hungry halogen lighting. Suitable for outdoor use, the range offers affordable products with high lumen efficiency and a long life.

Features

Class I, IP65

High lumen output

30,000h rated lifetime

Instant start

Negligible UV output

Elegant design

Unit D2 Kennetside, Bone Lane

Newbury, Berkshire

T: 01635 523 713 E: sales@kosnic.com W: <http://www.kosnic.com>

Specifications

	KFLDHS50Q465-W40-BLK	KFLDHS50Q465-W65-BLK
Input Current (mA)	46	46
Rated Life (hrs)	30000	30000
Switch Cycles	25000	25000
CRI	82	82
IP Rating	IP65	IP65
Class Protection	Class II	Class II
Connection	300 mm of H05RN-F 3 x 0.75 mm ²	300 mm of H05RN-F 3 x 0.75 mm ²
Width (mm)	206	206
Height (mm)	160	160
Depth (mm)	33	33
LMF at Lifetime	0.70	0.70
SDCM of CCT	<6	<6
Detection Angle (°)	110	110
Detection Zone	2 m to 10 m in 120 °	2 m to 10 m in 120 °
Ambient Light Threshold (lux)	3 to 2000	3 to 2000

KFLDHS50Q465-W40-BLK
KFLDHS50Q465-W65-BLK

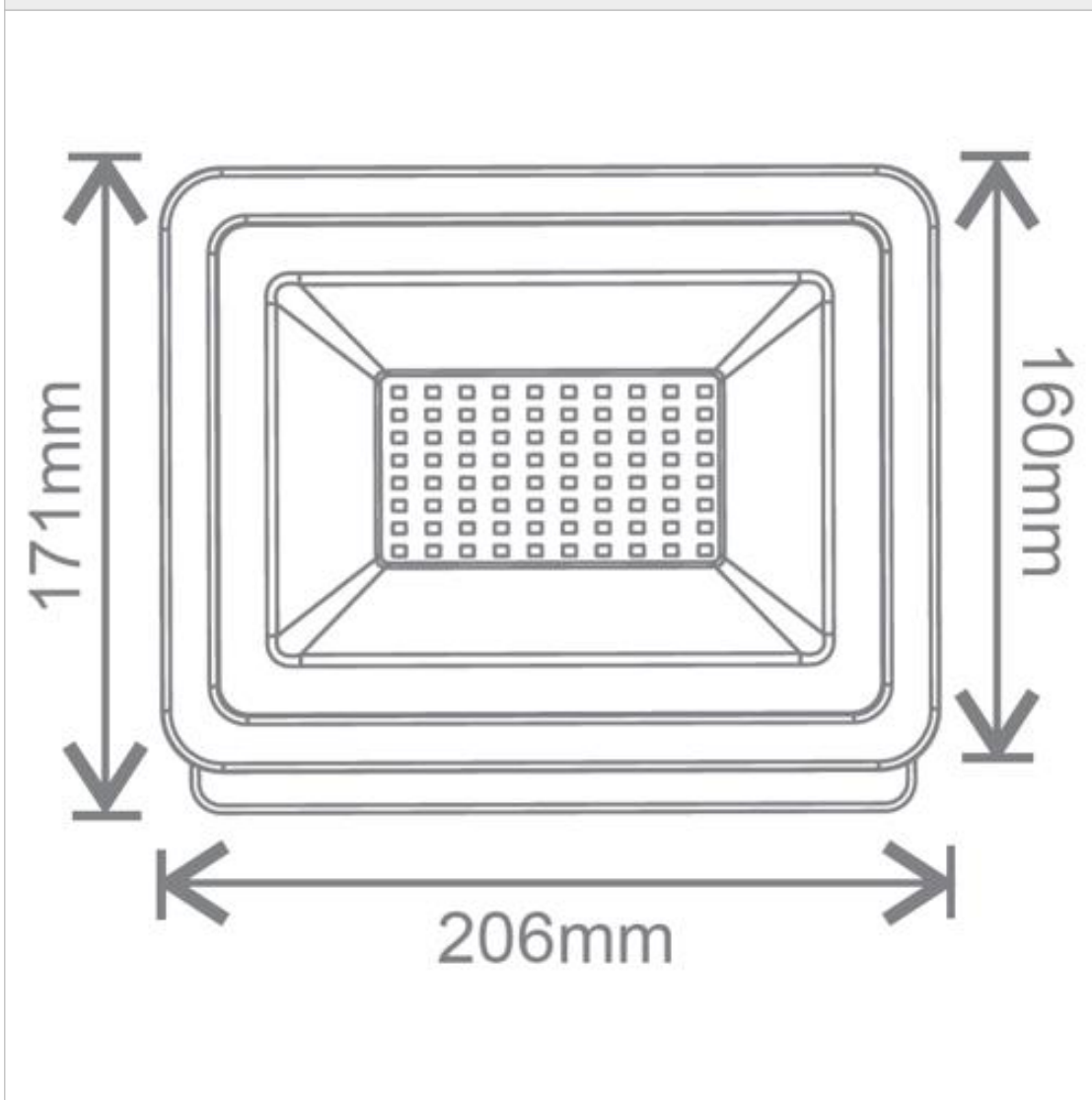

Datasheet generated from <https://www.electrika.com> last updated Tuesday, April 30, 2019 9:21:59 AM