



## **KFLDHS50Q465/S**

Rhine, LED Flood Light, 50W, with PIR sensor



## **Product Overview**

The Kosnic Rhine LED Floodlights make ideal replacements for energy-hungry halogen lighting. Suitable for outdoor use, the range offers affordable products with high lumen efficiency and a long life.

# Features

Class I, IP65

High lumen output

30,000h rated lifetime

Instant start

Negligible UV output

Elegant design

Adjustable PIR sensor

# Specifications

	KFLDHS50Q465/S-W40-BLK	KFLDHS50Q465/S-W65-BLK
<b>Input Current (mA)</b>	46	46
<b>Rated Life (hrs)</b>	30000	30000
<b>Switch Cycles</b>	25000	25000
<b>CRI</b>	82	82
<b>IP Rating</b>	IP65	IP65
<b>Class Protection</b>	Class II	Class II
<b>Connection</b>	300 mm of H05RN-F 3 x 0.75 mm <sup>2</sup>	300 mm of H05RN-F 3 x 0.75 mm <sup>2</sup>
<b>Width (mm)</b>	206	206
<b>Height (mm)</b>	210	210
<b>Depth (mm)</b>	55	55
<b>LMF at Lifetime</b>	0.70	0.70
<b>SDCM of CCT</b>	<6	<6
<b>Detection Angle (°)</b>	110	110
<b>Detection Zone</b>	2 m to 10 m in 120 °	2 m to 10 m in 120 °
<b>Ambient Light Threshold (lux)</b>	3 to 2000	3 to 2000

Unit D2 Kennetside, Bone Lane  
Newbury, Berkshire

T: 01635 523 713 E: sales@kosnic.com W: <http://www.kosnic.com>

KFLDHS50Q465/S-W40-BLK  
KFLDHS50Q465/S-W65-BLK

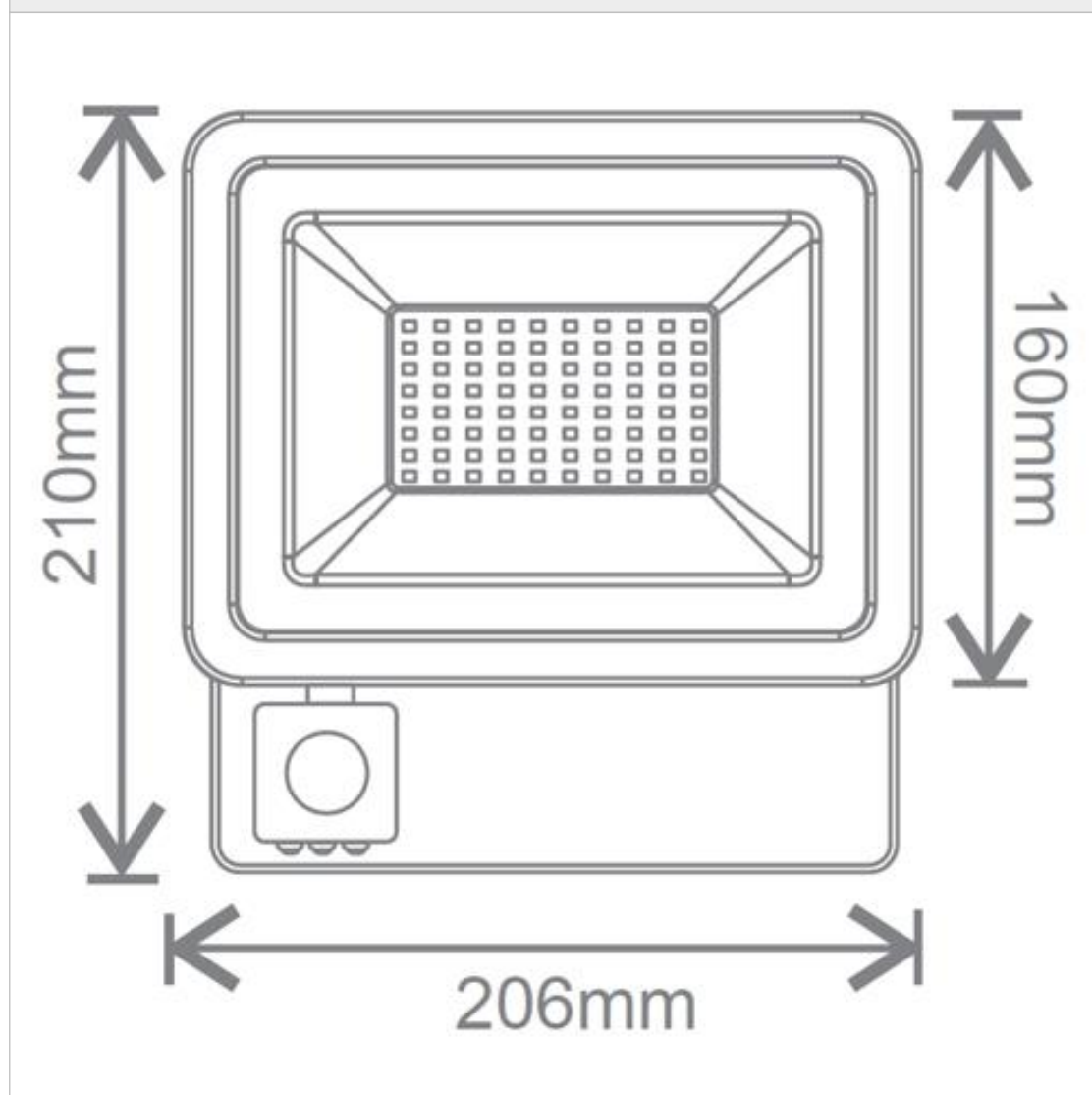

Datasheet generated from <https://www.electrika.com> last updated Tuesday, April 30, 2019 9:25:36 AM