

Technical Specification

Product Code: OV9300BK16MWEM

Description: 16W LED Bulkhead With Knockouts - Microwave Sensor & Emergency - IP65 - CTA - Black

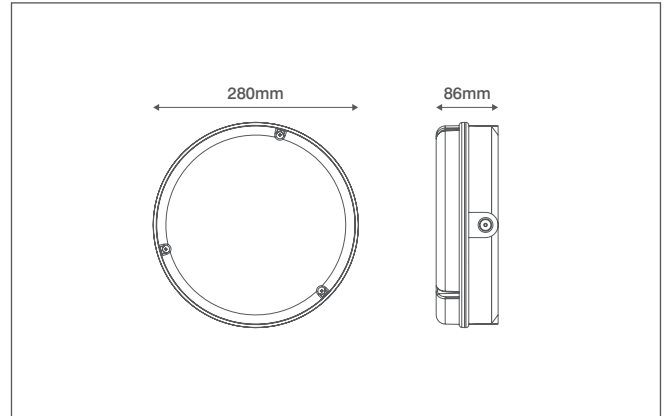

General Information

Dimensions	280mm Diameter x 86mm (D)
Materials	Base & Diffuser: Polycarbonate (UV Stabilised) Gear Tray: Powdercoated Steel LED Array: Aluminium Substrate
Finish	Black (RAL 9004)
Product Weight	0.97Kg
Corridor Function	Yes (10% or 25% Output)
Ingress Protection	IP65
Flammability	UL94-V2
Warranty	5 Years (4 Years Battery)

Supply & Power

Input Voltage & Frequency	200-240V~ 50/60Hz
Electrical Safety	Class II (Double Insulated)
LED Wattage	16W
Circuit Wattage	18W
Input Current	160mA
Power Factor	>0.95
Ambient Temperature (Ta)	0°C - +50°C
Critical Temperature	+80°C
LED Driver	Integrated
Termination	4 Pole Push-fit Terminals

Luminaire Output

Colour Temperature	3000K	4000K	6000K
Typical Luminous Flux	1500lm	1650lm	1550lm
Efficacy	83lm/W	91lm/W	86lm/W
Emergency Luminous Flux	122lm	122lm	122lm
Beam Angle	114°	114°	114°
CRI	>80		
LED Lifetime (L70)	30,000 Hours		

Microwave Information

Detection Angle	≤150°
Detection Distance	8 - 14 Metres Diameter
Installation Height	2.5 - 6 Metres
Hold Time (Time Delay)	5 secs / 90 secs / 3 mins / 10mins
Lux Level	15 Lux / Disable
Detection Area	50% or 100%
Dimming Stand-by Period	0 sec / 30 secs / 10 mins / +∞
Stand-by Dimming Level	10% or 25% (Corridor Functions)
HF System	5.8GHz ±75MHz
Master/Slave Facility	Not Available

Emergency Information

Installation Requirements	Can only be wired as maintained
Battery Specification	Li-Ion 2000mAh 3.7V
Battery Warranty	4 Years
Emergency Duration	3 Hours Minimum

