

Technical Specification

Product Code: OV9300WH16EMPC

Description: 16W LED Bulkhead With Knockouts - Emergency With Photocell - IP65 - CTA - White

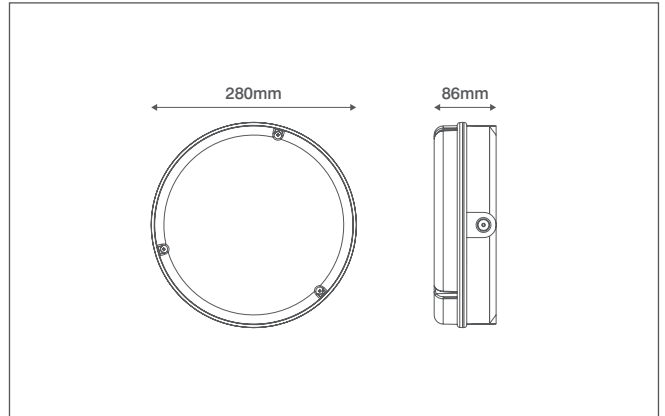

General Information

Dimensions	280mm Diameter x 86mm (D)
Materials	Base & Diffuser: Polycarbonate (UV Stabilised) Gear Tray: Powdercoated Steel LED Array: Aluminium Substrate
Finish	White (RAL 9010)
Product Weight	0.95Kg
Ingress Protection	IP65
Flammability	UL94-V2
Warranty	5 Years (4 Years Battery)

Supply & Power

Input Voltage & Frequency	200-240V~ 50/60Hz
Electrical Safety	Class II (Double Insulated)
LED Wattage	16W
Circuit Wattage	18W
Input Current	150mA (Max.)
Power Factor	>0.95
Ambient Temperature (Ta)	0°C - +50°C
Critical Temperature	+80°C
LED Driver	Integrated
Termination	4 Pole Push-fit Terminals

Luminaire Output

	3000K	4000K	6000K
Colour Temperature	3000K	4000K	6000K
Typical Luminous Flux	1500lm	1650lm	1550lm
Efficacy	83lm/W	91lm/W	86lm/W
Emergency Luminous Flux	122lm	122lm	122lm
Beam Angle	114°	114°	114°
CRI	>80		
LED Lifetime (L70)	30,000 Hours		

Emergency Information

Installation Requirements	Can be wired as maintained or non-maintained
Battery Specification	Li-Ion 2000mAh 3.7V
Battery Warranty	4 Years
Emergency Duration	3 Hours Minimum

Photocell Information

Switching Light Level 70 Lux (Automatic Dusk / Dawn)

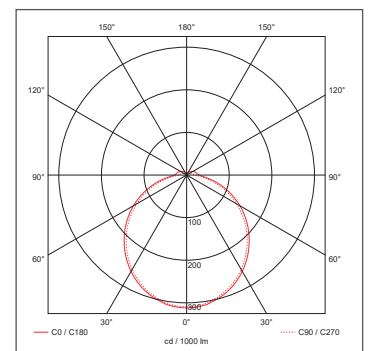

3000K

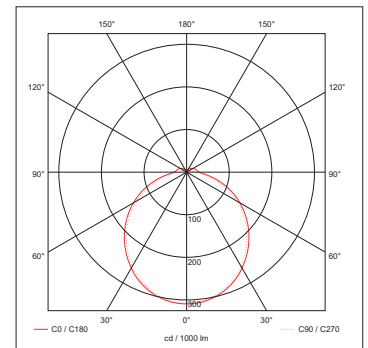

4000K

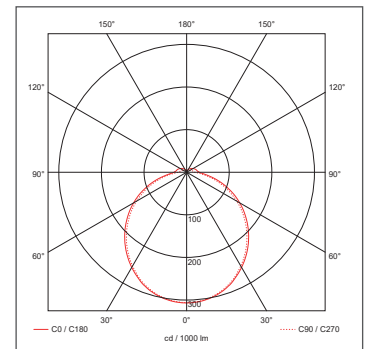

6000K

