



aperta ™

Battery Powered Wi-Fi Door Station

APWIFIDSBP (Silver)

APWIFIDSBLKBP (Black)



esp®

www.espuk.com





System Overview

Sunshade Mounting Bracket

HD Camera with IR-Cut

Weather Resistant Speaker

Push Button

Microphone

Memory Card Slot

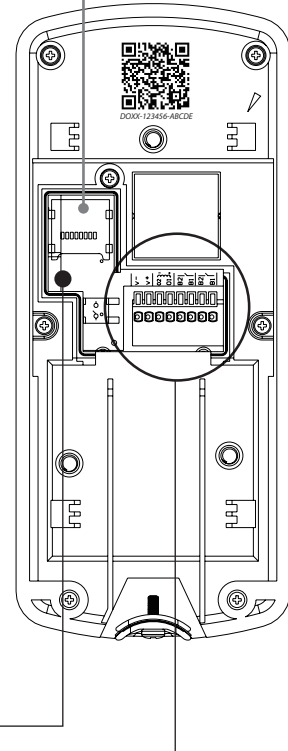
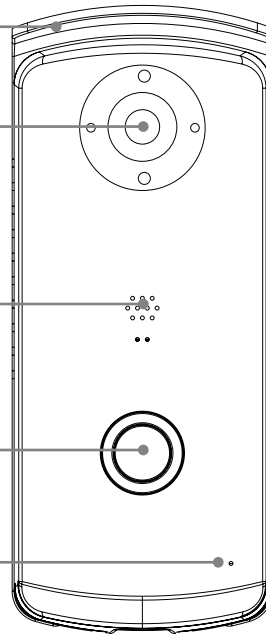

Reset Button

I/O Pin Connector

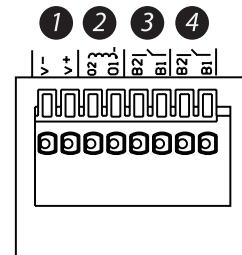

1. AC/DC: Power Input I/O
2. O2/O1: Wet Contact I/O for door unlock trigger
3. B2/B1: Dry Contact I/O for wired door chime trigger
4. B2/B1: Dry Contact I/O for motorized gate control





Connections

Optional Power Connection



Volt-free switch for lock release mechanism



Existing Bell Wiring

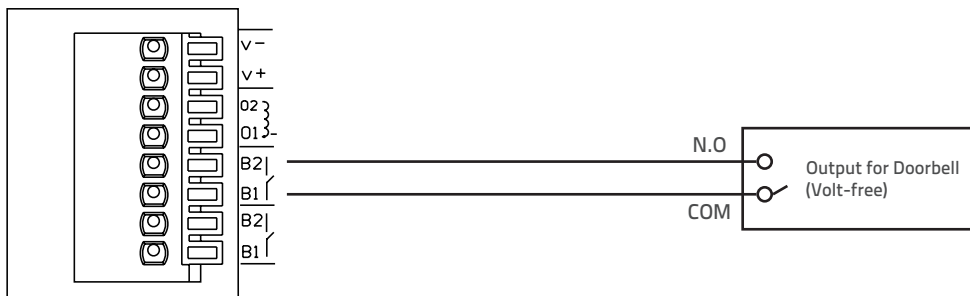



Connections

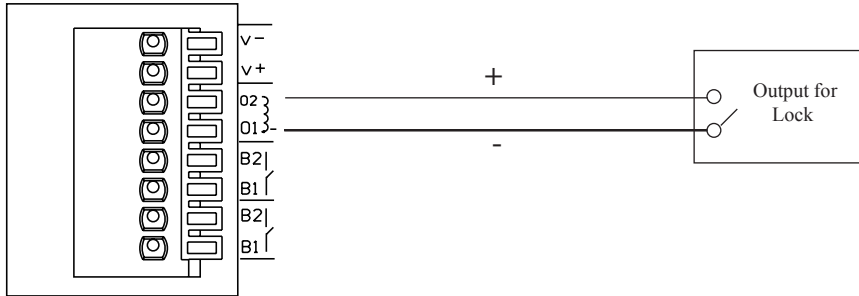

***Note:** For remote door unlock function with 12V/1A current output trigger;
The Door station requires a Hardwired power supply and must be a minimum of 15V 1.5A.

Optional Accessories



EVBPSSB
Lock Power Supply



EV-EXIT
Push to Release



EV-EBG
Emergency Release



EV-ML-250/500XT
Electromagnetic Lock



ENTERD
Electric Lock





Door Station Installation

It is strongly recommended APP & registration is complete prior to fixing the installation.

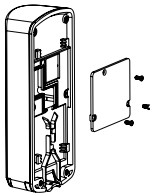

Step 1
Fasten the weather-seal cover

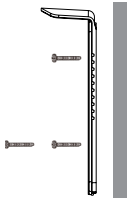

Step 2
Confirm position and mount the bracket with 3 screws

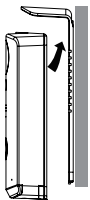

Step 3
Place the device on the mounting bracket

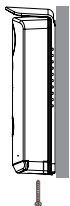

Step 4
Fasten the anti-theft screw.



APP Download and System Setup

Download and install the "ESP Aperta BP" APP to your device.



Insert Batteries

1. Unscrew the battery compartment screw .
2. Insert the batteries supplied. Make sure the polarity is as indicated.
3. After the batteries are inserted, the Push Button illuminator will begin to flash, indicating set up mode.

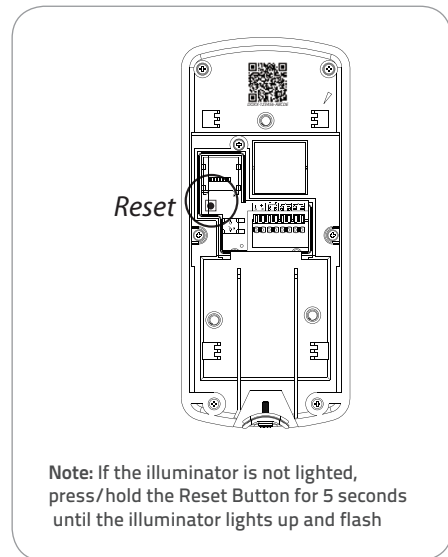
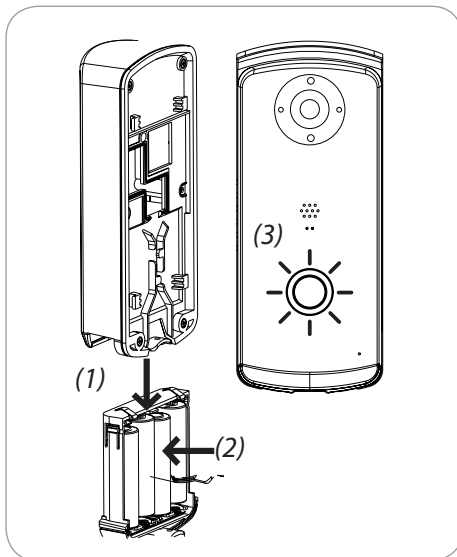



APP Setup

Please ensure the following;

1. The user's smart-phone is connected to the Wi-Fi network.
2. The Door Station is within the network's Wi-Fi range.
3. The network's key/password is available.

1.

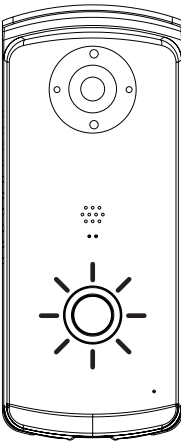

2.

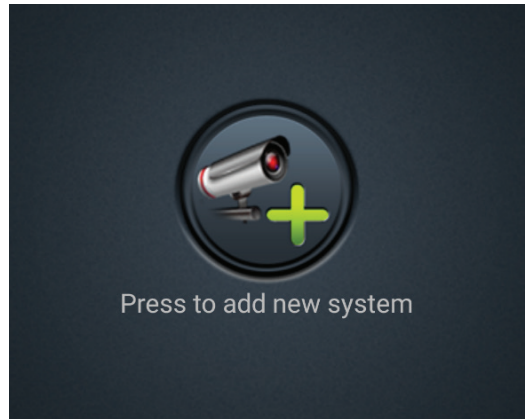

The door station's call button will be flashing, launch the APP & select 'add new system' or begin set up on next page.



APP Setup

3.

System Name:

DID:

Security Code:

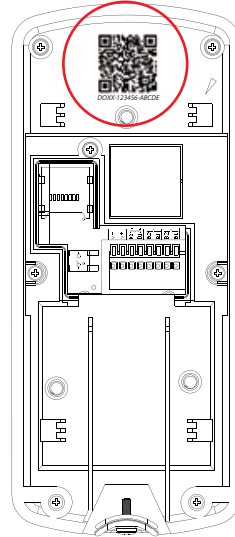

Select 'Scan DID Label', the label is at the rear of the door station.

(Note; DID; Device ID)

4.

System Name:

DID:

Security Code:

Enter a System Name (User defined).
Enter the default security code '123456' & select 'Save'



APP Setup

If using Android platform please follow the steps below before moving to page 13 .

For i-Phone please follow the additional steps on page 10.

Select 'SETUP' on Wi-Fi Setup & Follow the on screen instructions

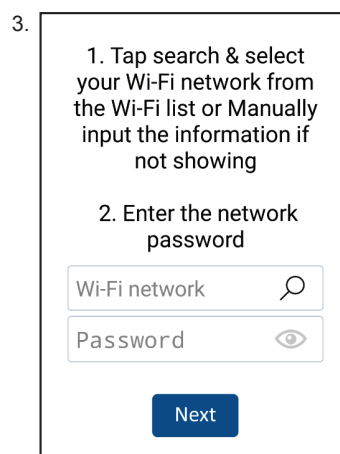
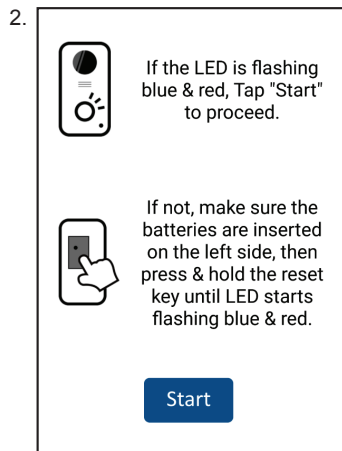
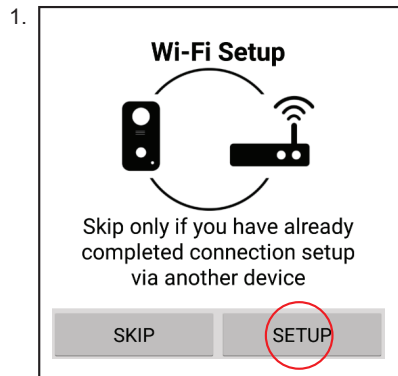



Additional I-Phone Set up (Page 1/3)

If using android platform please continue to page 13.
If using i-Phone please follow additional steps.

Select 'Setup'

1.

Wi-Fi Setup



Skip only if you have already completed connection setup via another device

Skip
Setup

Ensure correct network is selected

2.

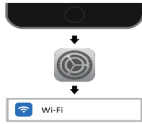

Go to device's Wi-Fi section and select the network your want to use. Come back here and tap "Next".

Next

3.

←

Setup Wizard

1. Make sure the Network below is correct one, if not, go to Wi-Fi section select again

2. Enter the network password then tap "Next"

ESP Wifi

Next

Enter the network password





Additional I-Phone Set up (Page 2/3)

Select 'Next'

4. **Setup Wizard**



Insert the batteries, if the LED is flashing blue & red, Tap "Next" to proceed.

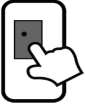

If not, make sure the battery are inserted on the left side, then press & hold the reset key until LED starts flashing blue & red.

Next

Exit APP and enter 'Settings' on I-phone

5. 

Go to device's Wi-Fi section and select the camera name (Starts with "RVDP-XXXXXX"). Come back here and tap "Next".

Next

6. **Settings**

- Airplane Mode
- Wi-Fi ESP Wifi >
- Bluetooth On >
- Mobile Data >
- Personal Hotspot Off >
- Carrier O2 - UK >

In the 'Settings' list select 'Wi-Fi'





Additional I-Phone Set up (Page 3/3)

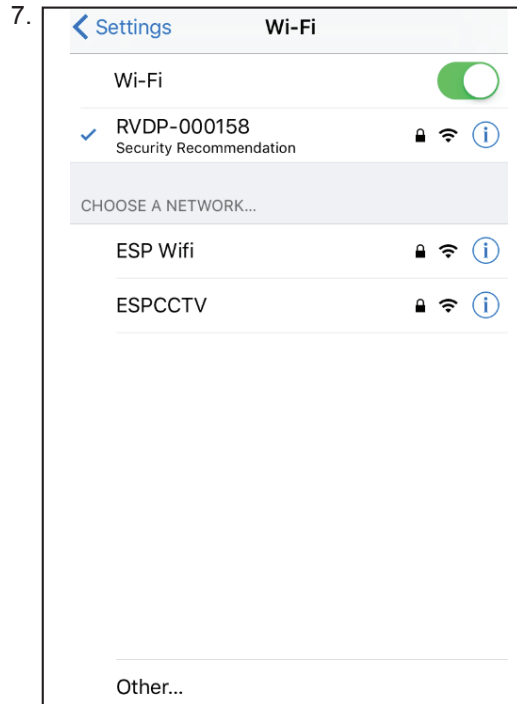

Select 'RVDP- XXXXXXX'

Enter Default Password;' 12345678'

8. Once connected, Return to APP





APP Setup

After entering the network details the screen will display progress made.

If the connection fails, Re-check network settings, reset the door station before re-attempting set up

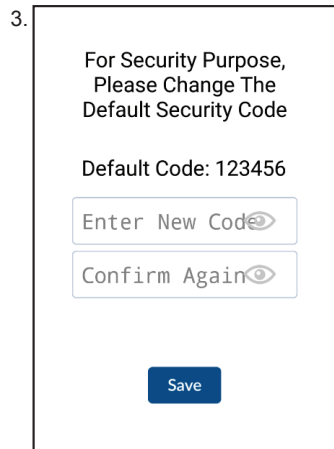
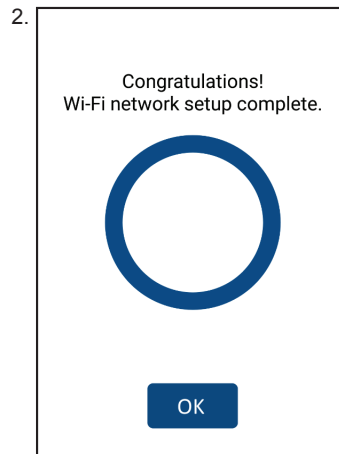
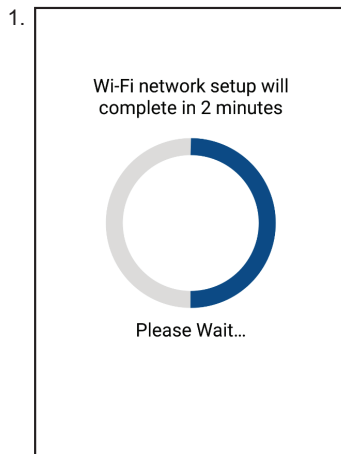



APP Setup

The APP will then indicate that the door station is in 'Power Saving Mode', this is due to the power saving features when running on batteries;

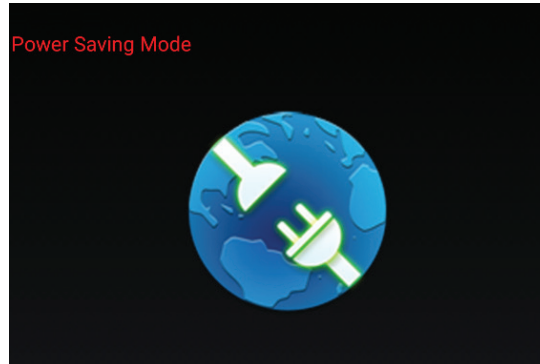

Press the call button on the door station to test connection.
If successful move door station to installation site and retest before fixing.

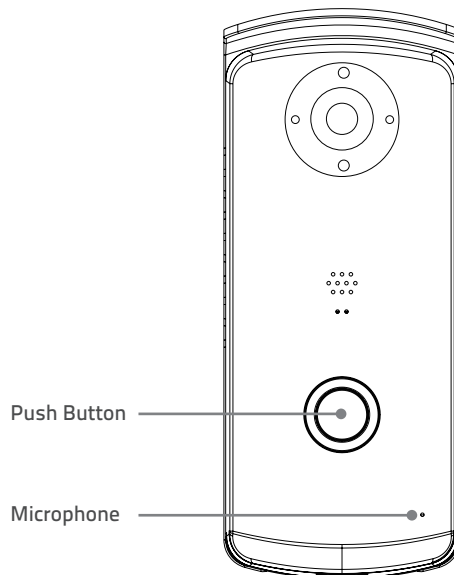



APP View Mode

Main Page

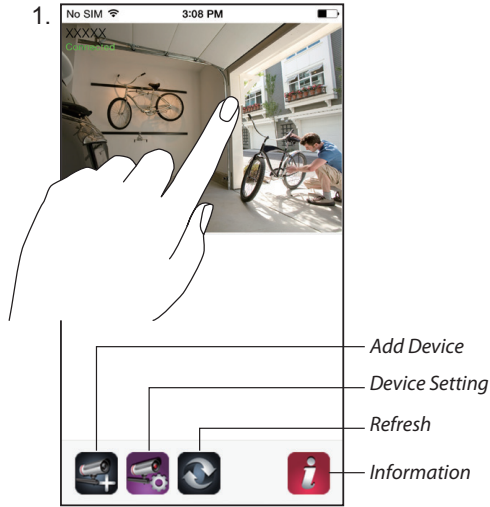

Live Video

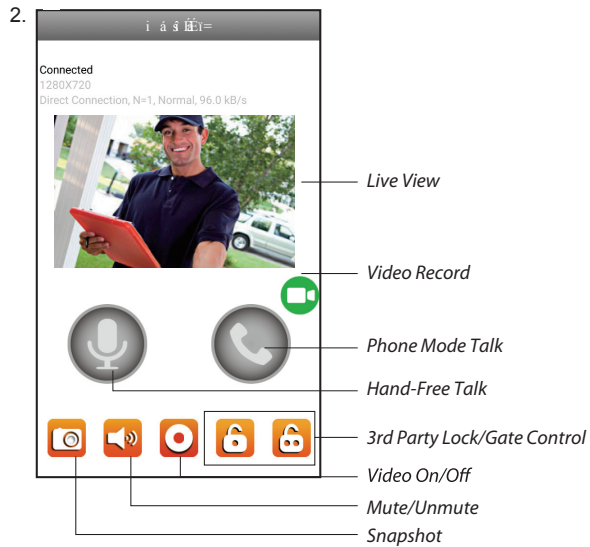



Best Performance Notes

Network Connection

Wi-Fi devices rely on a strong and stable signal from the network. Performance and reliability of Wi-Fi devices can become unpredictable if the signal strength is not sufficient for whatever the reason.

If Wi-Fi signal is a possible issue, one solution is the numerous Wi-Fi signal enhancing devices on the market to improve a network's performance.

In addition, network connection for all devices (Wi-Fi or LAN) is limited by the bandwidth allowance of the network, ensure that the bandwidth is suitable for the number of devices which are being supported.

Please note; APERTA requires 2.4GHZ Wi-Fi signal band.

APP Connection

Viewing from a mobile phone relies on a strong Wi-Fi signal or ensure a strong 3G or 4G signal is available.

For IOS it is recommended that the APP is left running in the background in order to benefit from the best performance.

For Android, the APP must be left running in the background to receive any service from the Door Station.

ESP are unable to guarantee that every device will be compatible with any ESP product and software supplied.

Specific models of phone, tablet or other device, the hardware it contains, the service provider, the types of data services offered and specific phone / device plan will all affect the performance of PC / mobile device for remote viewing.

Battery Power

Due to the nature of battery power the unit will limit functions and features during power saving mode.

If the user requires the constant use of the door station and full features it is recommended that a permanent power supply is fitted.





Viewing Recorded Footage

Method 1; Access the Micro SD card Is suitable if there is a **permanent power supply** to the door station.

This method is not available during power saving mode under battery conditions.

Method 2; Set Up Cloud Storage Account Is suited if the **door station is powered via batteries**

Method 1 : Accessing the Micro SD card via the APP.

1.

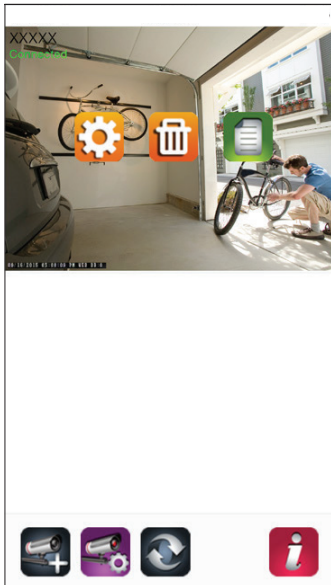

Launch APP & select



Followed by



2.

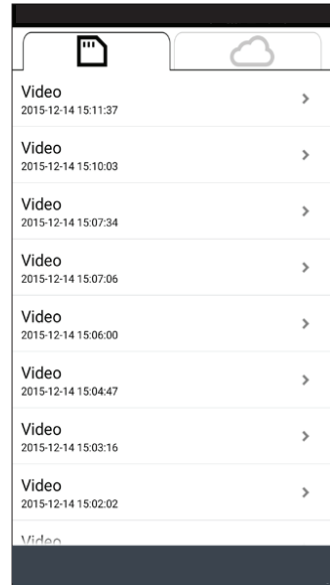



Viewing Recorded Footage

Method 2; Set Up Cloud Storage Account

Please ensure the following;

A Google Drive or Dropbox account will be required. Either account can be set up online for free. Once the account has been set up, the log-in details are required to follow procedure;

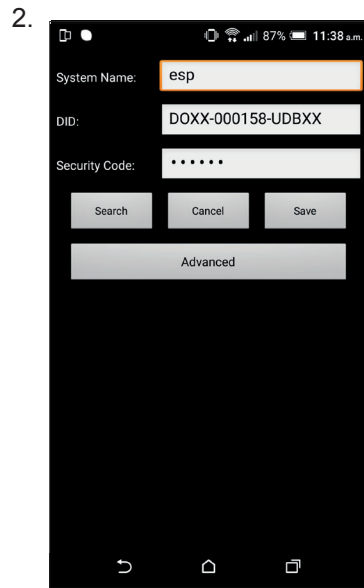

Launch APP & select



Followed by



Select 'Advanced'





Viewing Recorded Footage

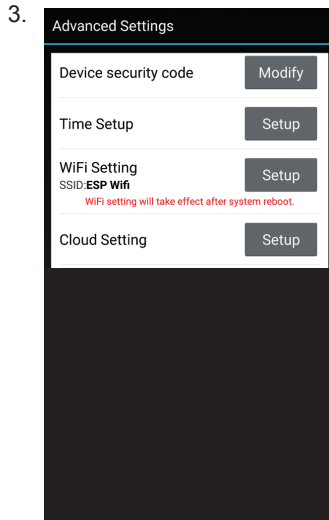

Select Cloud Setting 'Setup'

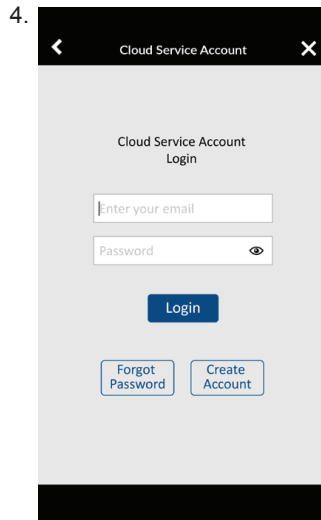

Select 'Create Account'

5.

Fields with * are required.

* User ID

 Please fill in your email account.

* First Name

* Last Name

* Password

 Please fill in 6 to 12 letters of numbers or alphabets.

* Confirm Password

 Please fill in your password again.

* Default Display Language

Complete the sections on screen & log-in with the account details



Viewing Recorded Footage

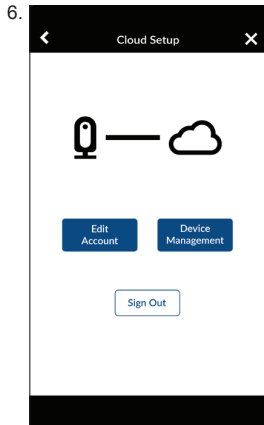

Select Device management and ADD the door station

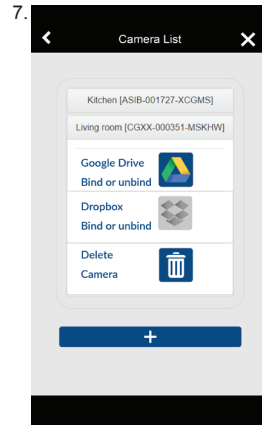

Select Google Drive or Dropbox, follow the on screen instruction to complete binding

Files stored on the Cloud can then be access via Google Drive/ Dropbox accounts or accessible via the main menu in the APP;

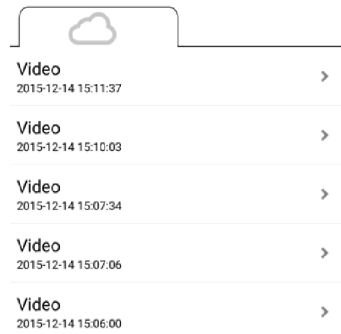
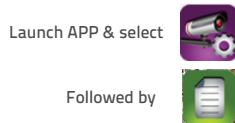



Advanced Settings

Additional settings can be accessed through the 'Advanced' Set up menu



Launch APP & select



Followed by

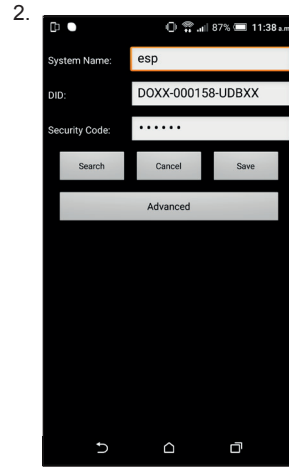

Select 'Advanced'

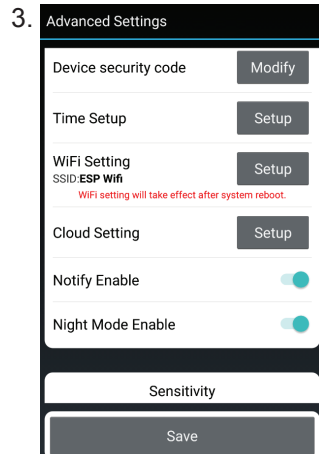



aperta 





aperta 





Elite Security Products

Unit 7, Target Park,
Shawbank Road, Lakeside,
Redditch B98 8YN



Telephone: 01527 51 51 50

Fax: 01527 51 51 43

Email: info@espuk.com

www.espuk.com

E&OE - Errors and omissions excepted.I17

